

Industrial Automation Catalog Section - U906

Panel Mount Sockets

Selection Guide

SR Series

SH Series

SY Series

Accessories

Dimensions

For up-to-date information, or to request a full copy of this catalog, contact us at www.idec.com or **800-262-IDEC**.

Due to continuous product improvements, specifications are subject to change without notice.

Relay and Timer Socket Selection Guide

Relay and Timer Sockets

Mounting	Series	Page	Part No.	No. of Poles	Receptacle	Terminal	Compatible IDEC Relay and Timer	
DIN Rail Snap-Mount 	SR	F-6	SR2P-05 SR2P-05C SR2P-06	2	8-Pin	M3.5 Screw	RR2P, GT5P, RTE-P1, GT3 (8-pin)	
			SR3P-05 SR3P-05C SR3P-06	3	11-Pin		RR3PA, RR2KP, RTE-P2 GT3 (11-pin)	
			SR3B-05	3	11-Blade		RR1BA, RR2BA, RR3B, RTE-B	
	SH	F-9	SH1B-05 SH1B-05C	1	5-Blade	M3.5 Screw Coil Terminal: M3	RH1B	
			SH2B-05 SH2B-05C	2	8-Blade	M3.5 Screw	RH2B	
			SH3B-05 SH3B-05C	3	11-Blade		RH3B, RH2LB	
			SH4B-05 SH4B-05C	4	14-Blade		RH4B	
	SY	F-13	SY2S-05 SY2S-05C	2	8-Blade	M3 Screw	RY2S, RY22S	
			SY4S-05 SY4S-05C	4	14-Blade		RU4S, RY4S, RY42S, RY2KS, RY2LS, RM2S, GT5Y	
	SM	F-15	SM2S-05 SM2S-05C				RU2S	
	Panel Mount 	SR	F-16	SR2P-51	2	8-Pin	Solder	RR2P, RAPP, RBPP, GT5P, RTE-P1, GT3 (8-pin)
				SR3P-51	3	11-Pin		RR3PA, RR2KP, RTE-P2, GT3 (11-pin)
				SR3B-51	3	11-Blade		RR1BA, RR2BA, RR3B
SH		F-17	SH1B-51	1	5-Blade	RH1B, RAHB, RBHB		
			SH2B-51	2	8-Blade	RH2B, RAMB, RBMB		
			SH3B-51	3	11-Blade	RH3B, RH2LB		
			SH4B-51	4	14-Blade	RH4B		
SY		F-19	SY2S-51	2	8-Blade	RY2S, RY22S		
			SY4S-51	4	14-Blade	RY4S, RY42S, RY2KS, RY2LS, RM2S, GT5Y		
PCB Mount 		SH	F3-20	SH1B-62	1	5-Blade		PC Board
	SH2B-62			2	8-Blade	RH2B, RAMB, RBMB		
	SH3B-62			3	11-Blade	RH3B, RH2LB		
	SH4B-62			4	14-Blade	RH4B		
	SY	F3-21	SY2S-61	2	8-Blade	RY2S, RY22S		
			SY4S-61	4	14-Blade	RY4S, RY42S, RY2KS, RY2LS, RM2S, GT5Y		
			SY4S-62	4	14-Blade	RY4S, RY42S, RY2KS, RY2LS, RM2S, GT5Y		
Surface Mount 	SH	F-23	SH2B-02	2	8-Blade	M3.5 Screw	RH2B, RAMB, RBMB	
For Panel Mounted Timers								
	SR	F-23	SR6P-M08G	2	8-pin	M3.5 Screw	GE1A; RTE-P1; GT3A-1,-2,-3; GT3D-1,-2,-3; GT3W (8-pin); GT3S; GT3F	
			SR6P-M11G		11-pin		RTE-P2; GT3A-4,-5,-6; GT3D-4,-8; GT3W (11-pin)	



For relay mounting accessories, see page F-24.

Specifications	Rated Insulation Voltage	300V; except SH1B and SY4S-62: 250V
	Rated Current	SR/SH/SM: 10A, SY: 7A (SH1B coil terminal 7A)
	Insulation Resistance	100MΩ minimum
	Dielectric Strength	2,000V AC, 1 minute
	Material Grade	UL94V-0

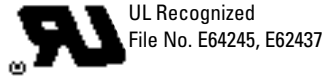

File No. BL950813332307 *



1. * Applicable to DIN rail sockets only.

Relay Socket Part Numbering Guide

Relay socket part numbers are composed of 5 part number codes. When ordering a relay socket, select one code from each category.
Example: SR2P-05C

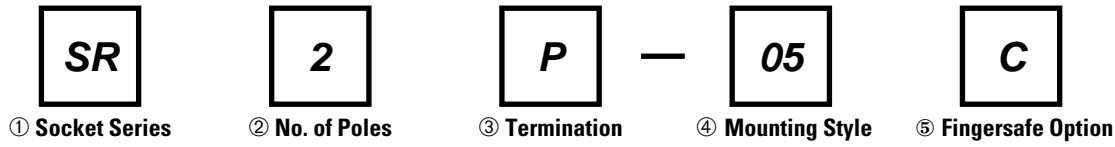

F

Part Numbers: Relay Sockets

	Description	Part Number Code	Remarks
① Socket Series	SR	SR	For use with RR series relays
	SH	SH	For use with RH series relays
	SY	SY	For use with RY series relays
	SM	SM	For use with RU2, RM2 series relays
② No. of Poles	1-pole	1	SH series
	2-pole	2	SR, SH, SM, and SY series
	3-pole	3	SR, and SH series
	4-pole	4	SH series
③ Termination	Tubular pin	P	SR series
	Blade	B	SH series
	Solder/blade	S	SY and SM series
④ Mounting Styles	DIN rail snap-mount	05	To decide between configuration 05 and 06, see pictures and schematics beginning on page F-6
		06	Model 05 is available as 05C with a fingersafe option; see ⑤ below
	Panel mount	51	
	PC board mount	61	
62			
⑤ Fingersafe Option	With finger-protection terminals	C	Available only on SR, SH, SM, and SY series snap-mount sockets
	Without finger-protection terminals	Leave blank	



2. For hold-down springs and clips for DIN rail snap-mount, panel mount, and PC board mount, see page F-4.
3. For socket accessories, see page F-24.

Hold-Down Springs and Clips Selection Guide

DIN Rail Snap-Mount Sockets

Socket Part No.	Applicable Relays, Timer	Hold-Down Pullover Spring	Hold-Down Clip (side notch)	Hold-Down Clip (top notch)
SR2P-05 SR2P-05C	RR2P	SR2B-02F1	SFA-203	—
	RTE-P1, GT3, GT5P	—	SFA-203	—
SR2P-06	RR2P	SR2B-02F1	SFA-202	—
	GT3 (8-pin), RTE-P1, GT5P	—	SFA-202	—
SR3P-05 SR3P-05C	RR3PA	SR3B-02F1	SFA-203	—
	RR2KP	SR3P-06F3	SFA-203	—
	RTE-P2, GT3 (11-pin)	—	SFA-203	—
SR3P-06	RR3PA	SR3B-02F1	SFA-202	—
	RR2KP	SR3P-06F3	SFA-202	—
	RTE-P2, GT3 (11-pin)	—	SFA-202	—
SR3B-05	RR1BA, RR2BA, RR3B, RTE-B	SR3B-02F1	SFA-202	—
SH1B-05 SH1B-05C	RH1B	SY2S-02F1	—	SFA-101 SFA-202
SH2B-05 SH2B-05C	RH2B	SY4S-02F1	—	SFA-101 SFA-202
SH3B-05 SH3B-05C	RH3B, RH2LB	SH3B-05F1	—	SFA-101 SFA-202
SH4B-05 SH4B-05C	RH4B	SH4B-02F1	—	SFA-101 SFA-202
SY2S-05 SY2S-05C	RY2S, RY22S	SY2S-02F1	—	SFA-101 SFA-202
SY4S-05 SY4S-05C	RY4S, RY42S, RY2LS, RM2S	SY4S-51F1	—	SFA-101 SFA-202
	RY2KS, GT5Y	(SY4S-51F3)	—	SFA-202

F

1. Hold-down springs work in conjunction with hold-down spring anchors included with DIN rail sockets.
2. When mounting relays with a check button onto panel mount or PC board mount sockets, use the hold-down spring shown in parenthesis. Hold-down springs for relays with check buttons are not available for SR2P-51.
3. For close mounting of panel mount or PC mount sockets, use hold-down clips rather than hold-down springs.
4. SFA-101, SFA-202 and SFA-302 come in pairs.

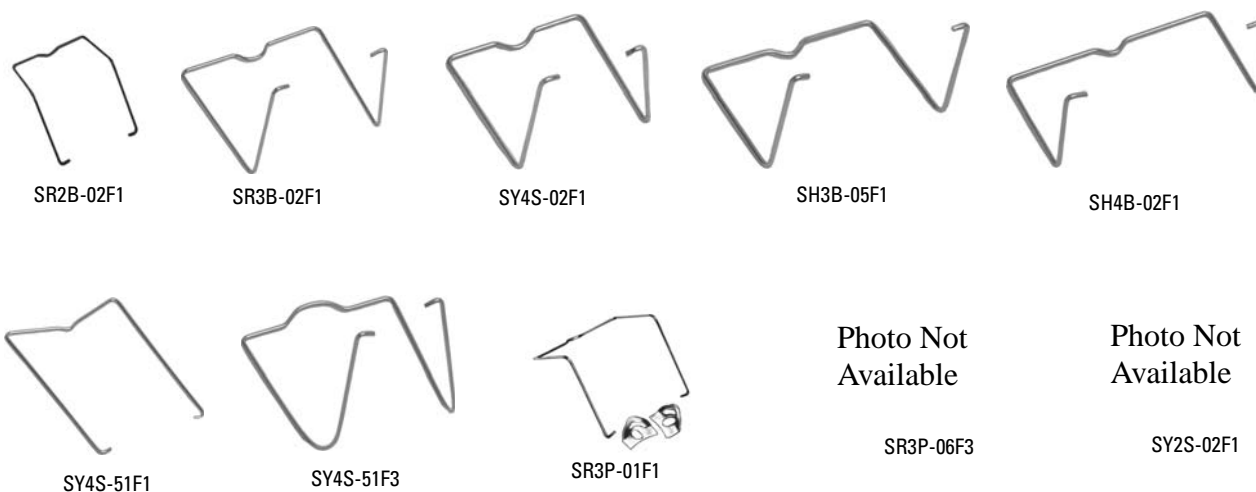

Panel and PC Board Mount Sockets

Socket Part No.	Applicable Relays, Timer	Hold-Down Pullover Spring	Hold-Down Clip (side notch)	Hold-Down Clip (top notch)
SR2P-51	RR2P	SR3P-01F1	—	—
	GT3 (8-pin), RTE-P1	—	SFA-402	—
SR3P-51	RR3PA	SR3P-01F1	—	—
	RR2KP	SR3P-51F3	—	—
	GT3 (11-pin), RTE-P2	—	SFA-402	—
SR3B-51	RR1BA, RR2BA, RR3B, RTE-B	SR3B-02F1	—	—
SH1B-51 SH1B-62	RH1B	SY4S-51F1	—	SFA-301 SFA-302
SH2B-51	RH2B	SY4S-51F1 (SY4S-02F1)	—	SFA-301 SFA-302
SH2B-62	RH2B	SY4S-51F1 (SY4S-02F1)	—	—
SH3B-51 SH3B-62	RH3B, RH2LB	SY4S-51F1 (SY4S-02F1)	—	SFA-301 SFA-302
SH4B-51 SH4B-62	RH4B	SY4S-51F1 (SH4B-02F1)	—	SFA-301 SFA-302
SY2S-51 SY2S-61	RY2S, RY22S	SY4S-51F1	—	SFA-301 SFA-302
SY4S-51 SY4S-61	RY4S, RY42S, RY2LS	SY4S-51F1 (SY4S-02F1)	—	SFA-301 SFA-302
	RY2KS	SY4S-51F1 (SY4S-02F3)	SFA-302	—
	GT5Y	—	SFA-302	—
SY4S-62 *	RY4S, RY42S, RY2LS, RM2S	SY4S-51F1 (SY4S-02F1)	—	—
	RY2KS	SY4S-51F1 (SY4S-02F3)	—	—

* Does not accept hold down clips

F



SFA-101



SFA-202



SFA-302

Photo Not Available

SFA-301



SFA-203



SFA-402

SR Series: Panel Mount Sockets



SR3B-51	
Style	11-blade, panel mount
Terminal	Solder
Electrical Rating	300V, 10A
Compatible Relay	RR1BA, RR2BA, RR3B
Compatible Timer	RTE-B
Hold-Down Spring	SR3B-02F1 (for relays only)

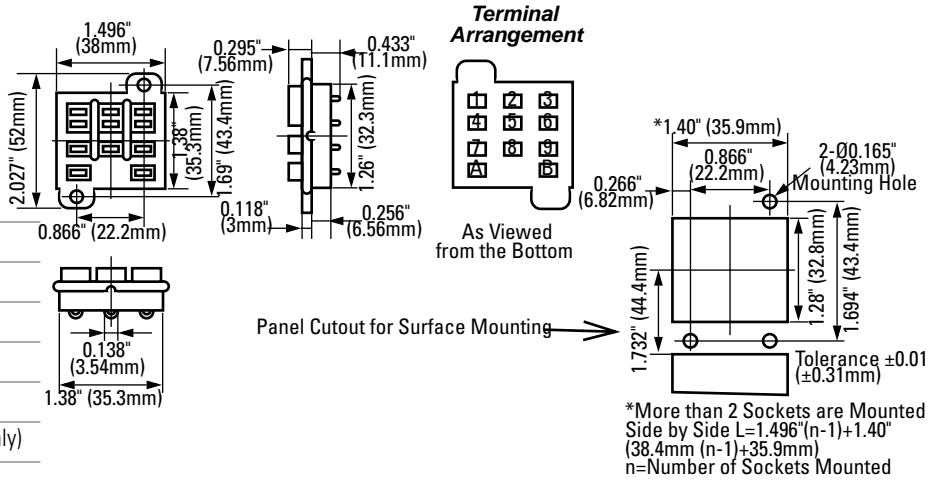

SR2P-51	
Style	8-pin octal, panel mount
Terminal	Solder
Electrical Rating	300V, 10A
Compatible Relay	RR2P
Compatible Timer	RTE-P1, GT3 (8-pin), GT5P
Hold-Down Spring	SR3P-01F1 (for relay only)
Hold-Down Clip	SFA-402 (for GT3 8-pin) SFA-302 (for GT5P)

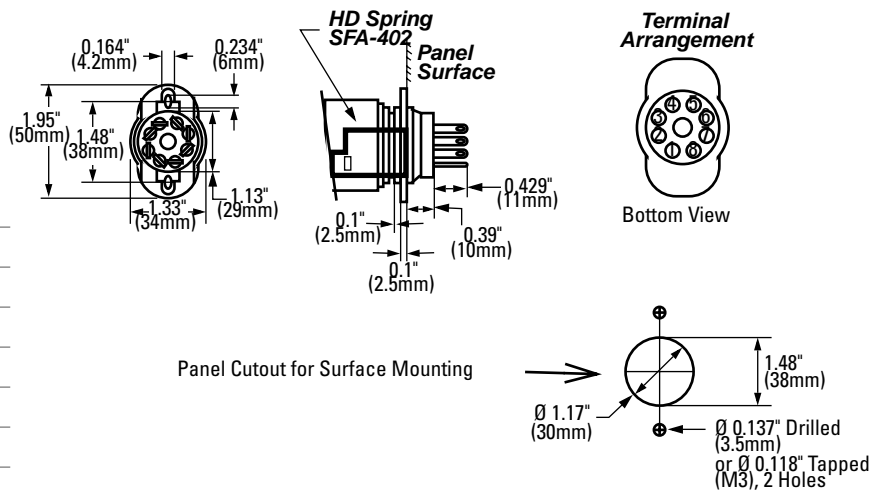

SR3P-51	
Style	11-pin octal, panel mount
Terminal	Solder
Electrical Rating	300V, 10A
Compatible Relay	RR3PA, RR2KP
Compatible Timer	GT3 (11-pin), RTE-P2
Hold-Down Spring	SR3P-01F1 for RR3PA SR3P-51F3 for RR2KP
Hold-Down Clip	SFA-402 (for GT3 11-pin, RTE-P2)

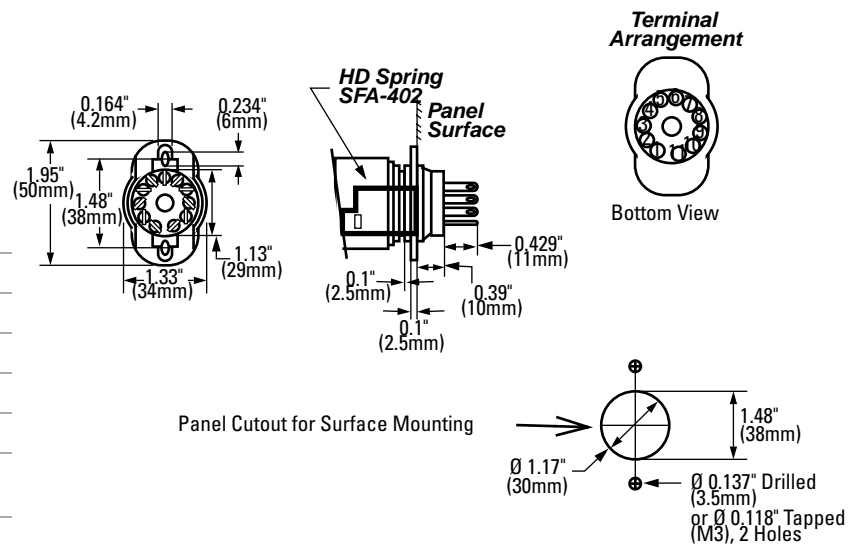

1. For socket mounting accessories, see page F-24.
2. For hold-down clip/spring selections, see page F-4.

SH Series: Panel Mount Sockets



SH1B-51

Style	5-blade, panel mount
Terminal	Solder
Electrical Rating	300V, 10A
Compatible Relay	RH1B
Hold-Down Spring	SY4S-51F1
Hold-Down Clip	SFA-301 (top notch), SFA-302 (side notch)

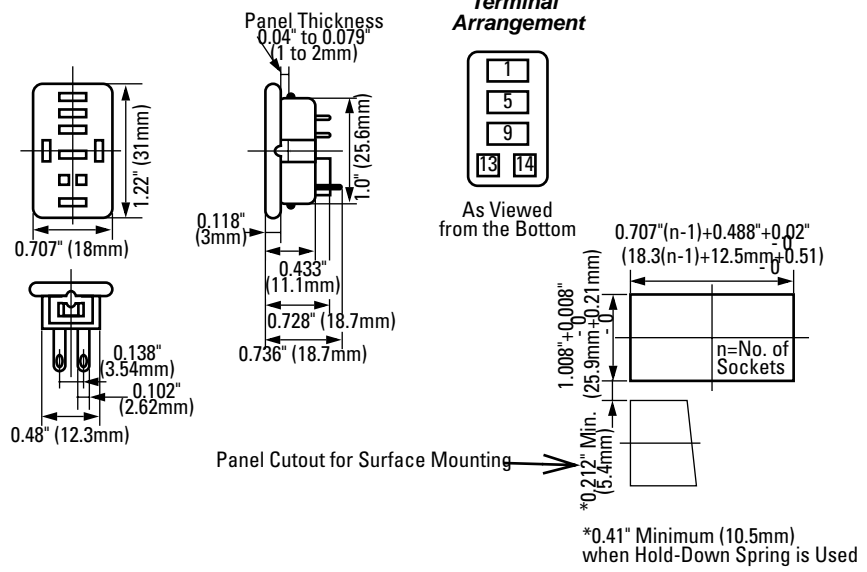

SH2B-51

Style	8-blade, panel mount
Terminal	Solder
Electrical Rating	300V, 10A
Compatible Relay	RH2B
Hold-Down Spring	SY4S-51F1 SY4S-02F1 for RH2B-4C
Hold-Down Clip	SFA-301 (top notch), SFA-302 (side notch)

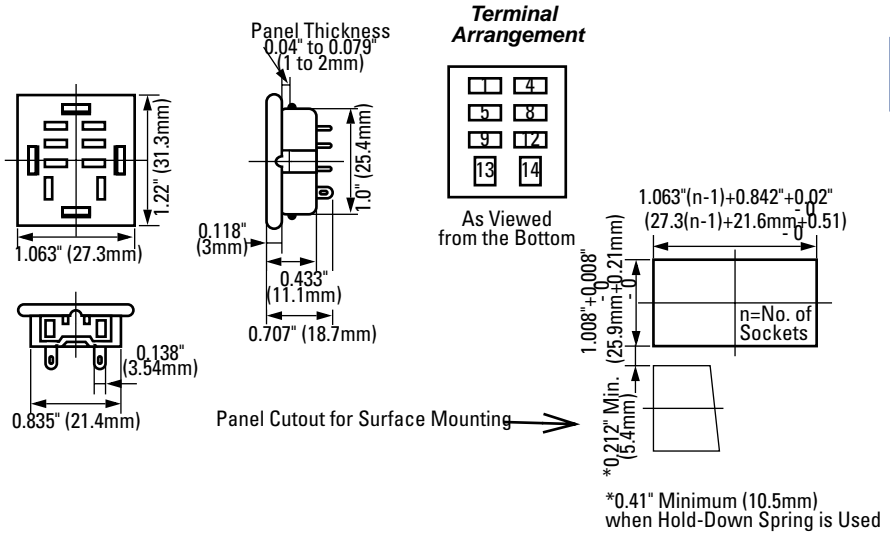

F



1. For socket mounting accessories, see page F-24.
2. For hold-down clip/spring selections, see page F-4.

SH Series: Panel Mount Sockets, continued

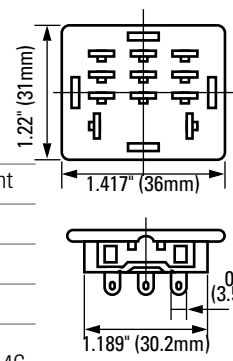
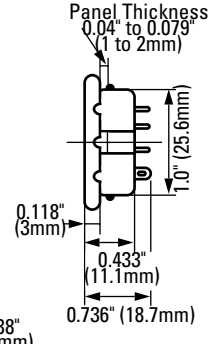
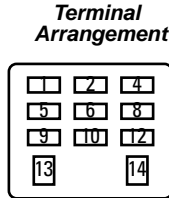

SH3B-51	
Style	11-blade, panel mount
Terminal	Solder
Electrical Rating	300V, 10A
Compatible Relay	RH3B, RH2LB
Hold-Down Spring	SY4S-51F1 SY4S-02F1 for RH3B-4C
Hold-Down Clip	SFA-301 (top notch), SFA-302 (side notch)

Panel Thickness 0.04" to 0.079" (1 to 2mm)

As Viewed from the Bottom

Panel Cutout for Surface Mounting

*0.212" Min. (5.4mm)

*0.41" Minimum (10.5mm) when Hold-Down Spring is Used

F

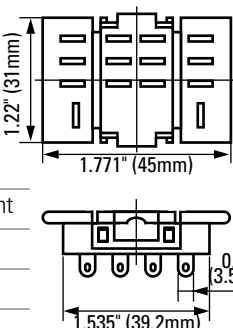
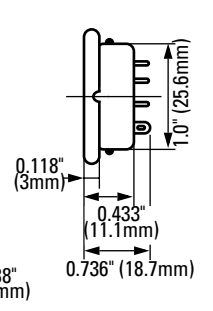
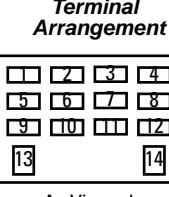

SH4B-51	
Style	14-blade, panel mount
Terminal	Solder
Electrical Rating	300V, 10A
Compatible Relay	RH4B
Hold-Down Spring	SY4S-51F1, SY4S-02F1
Hold-Down Clip	SFA-301, SFA-302

Panel Thickness 0.04" to 0.079" (1 to 2mm)

As Viewed from the Bottom

Panel Cutout for Surface Mounting

*0.212" Min. (5.4mm)

*0.41" Minimum (10.5mm) when Hold-Spring is Used



1. For socket mounting accessories, see page F-24.
2. For hold-down clip/spring selections, see page F-4.

SY Series: Panel Mount Sockets



SY2S-51

Style	8-blade, panel mount
Terminal	Solder
Electrical Rating	300V, 7A
Compatible Relay	RY2S, RY22S
Hold-Down Spring	SY4S-51F1
Hold-Down Clip	SFA-301 (top notch), SFA-302 (side notch)

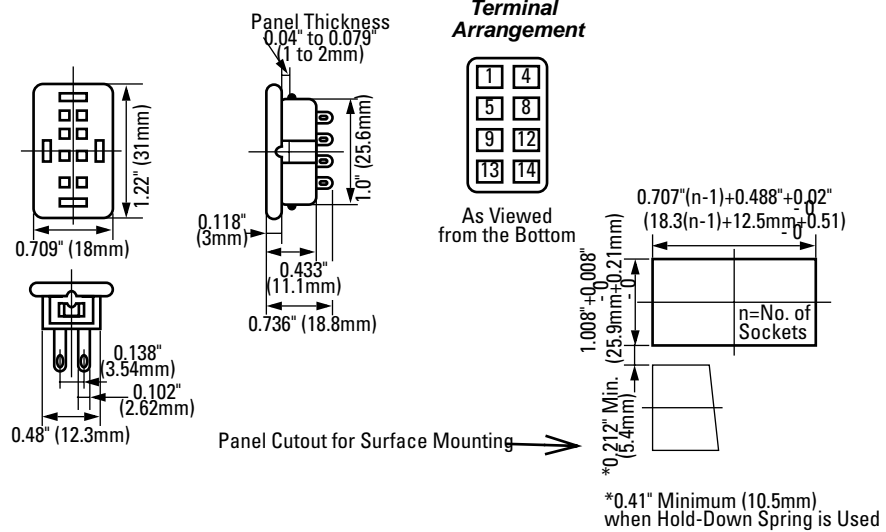

SY4S-51

Style	14-blade, panel mount
Terminal	Solder
Electrical Rating	300V, 7A
Compatible Relay	RY4S, RY42S, RM2S, RY2KS, RY2LS, RU4S, RU2S
Compatible Timer	GT5Y
Hold-Down Spring	SY4S-51F1 for all relays except; SY4S-02F3 for RY2KS relay
Hold-Down Clip	SFA-301 (top notch), SFA-302 (side notch)

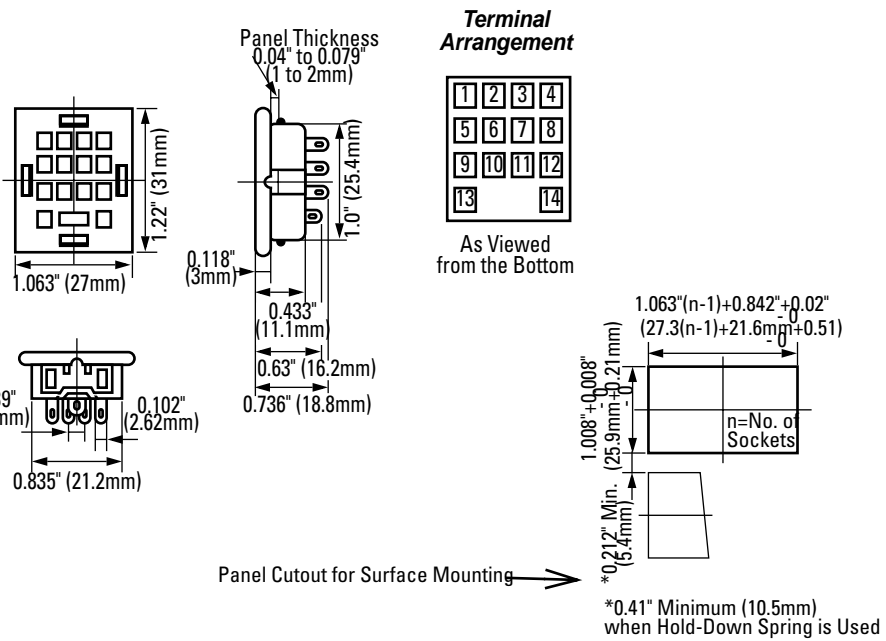







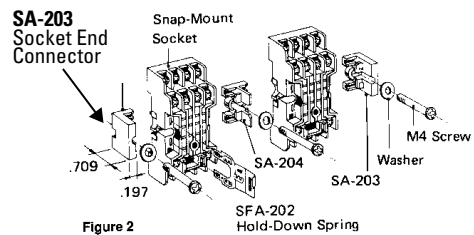

F



1. For socket mounting accessories, see page F-24.
2. For hold-down clip/spring selections, see page F-4.

Accessories

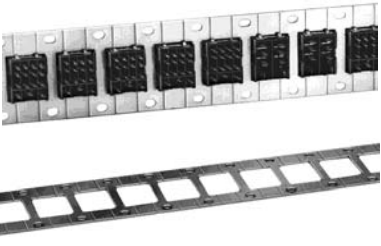

Description	Appearance	Use with	Part No.	Remarks
Aluminum DIN Rail (1 meter length)		All DIN rail sockets	BNDN1000	'DEC offers a low-profile DIN rail BNDN-1000). The BNDN-1000 is designed to accommodate snap-mount sockets and surface mount sockets. Made of durable extruded aluminum, the BNDN-1000 measures 0.413" in height and 1.37" (35mm) in width (DIN standard). Standard length is 39" (1,000mm).
DIN Rail End Stop		BNDN1000 DIN rail	BNL5	9.1 mm wide.
Surface Mount End Connector		SY2S, SY4S, SR3B, SH1B, SH2B, SH3B, SH4B	SA-203	For use on ends of socket groupings when surface mounting.
			SA-204	For use between adjoining sockets when surface mounting.
Surface Mount Connector		SY2S, SY4S, SR3B, SH1B, SH2B, SH3B, SH4B	SA-405	For use between adjoining sockets when surface mounting.
DIN Rail Spacer		All DIN rail sockets	SA-406	
Steel Mounting Plates (for panel mount sockets)		SY4S-51, SH2B-51	SA-402	11.42" length with 10 holes.
		SY4S-51, SH2B-51	SA-403	23.33" length with 21 holes.
Relay Holders		RH2B, RM2S, RY4S, RY42S, RY2LS, RAMB, RBMB	RH-01	For diagram, see next page.
		RY2S, RAHB, RBHB, RH1B	RH-03	
Replacement Hold-Down Spring Anchor (horseshoe clip)		All DIN rail sockets	Y778-011	For use with hold-down springs (bale wire types) or DIN rail mount sockets. 2 pieces included with each socket.

F

Instructions

Mounting Snap-Mount Sockets

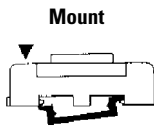

Figure 1

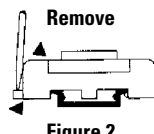

Figure 2

Snap-mount sockets are designed to mount on the BNDN-1000 mounting rail. The built-in mounting clip eliminates mounting hardware and reduces mounting time by 80%.

To mount see Figure 1. Place the end of the socket (end opposite of mounting clip against the outer edge of the rail). Press the socket down firmly until the clip snaps onto the mounting rail. To remove see Figure 2. Pull out the mounting clip with a screwdriver, and lift the socket.

For spacing between adjoining sockets, use the SA-406 DIN rail spacer. Spacers are 0.195" wide. Spacing can be adjusted according to the number of spacers added. Spacers snap on and off easily like snap-mount sockets.

To prevent side-to-side movement, use a BNL-5 end clip at **each** end of every socket row.

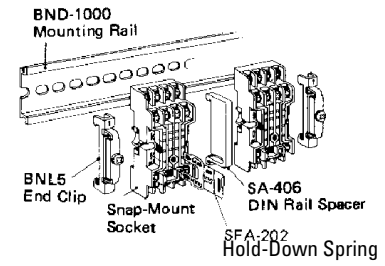

Mounting Relay Holders

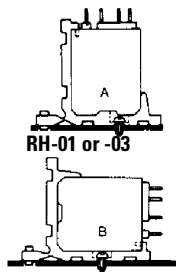

Figure 1

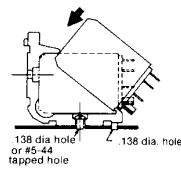

Figure 2

Mount directly onto panel boards in two alternate positions: A and B (see Figure 1).

To mount the relay into the holder, hook the bottom edge of the relay case (coil terminal side) onto the relay holder (see Figure 2).

Push down until the relay snaps into place.

Mounting Hold-Down Springs

Take the two anchor clips (horseshoe / U-shaped piece) that come with the socket and insert into the slits on both sides of the socket. Make sure the raised notches on the anchor clip face into the socket.

Plug relay into socket

Insert the open ends of the hold-down spring into either the first or second hole of the anchor clip. The relay-spring combination will determine which hole should be used.

Slide spring over relay.

F

Dimensions

Surface Mount Sockets (SH2B-02)

IDEC surface mount sockets (SH2B-02) are also designed to mount individually or collectively on a flat surface without the use of a DIN rail. Use the mounting screw between adjoining sockets and at the outer ends of the row of sockets.

Dimension Table

Socket Part No.	Dimension A
SH2B-02	1.14"

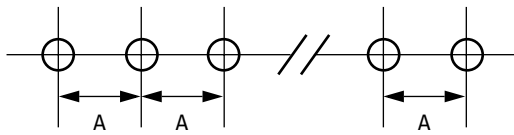

1. Drawing is not to scale.

Snap-Mount Sockets

F Snap-mount sockets are designed to mount individually or collectively without using a rail. Use a SA-405 connector or SA-204 connector between adjoining sockets (see Figures 1 and 2). Use the SA-203 end connector at the outer ends of each socket row when using the SA-204 connector (see Figure 2).

Dimension Table

Socket Part No.	Dim. B	Dim. C	Dim. D
SY2S-05, SY2S-05C	0.669"	0.826"	0.866"
SY4S-05, SY4S-05C	1.024"	1.181"	1.220"
SR3B-05	1.496"	1.693"	1.732"
SH1B-05, SH1B-05C	0.630"	0.787"	0.827"
SH2B-05, SH2B-05C	1.024"	1.181"	1.220"
SH3B-05, SH3B-05C	1.417"	1.575"	1.614"
SH4B-05, SH4B-05C	1.811"	1.969"	2.008"

Using an SA-406 Connector

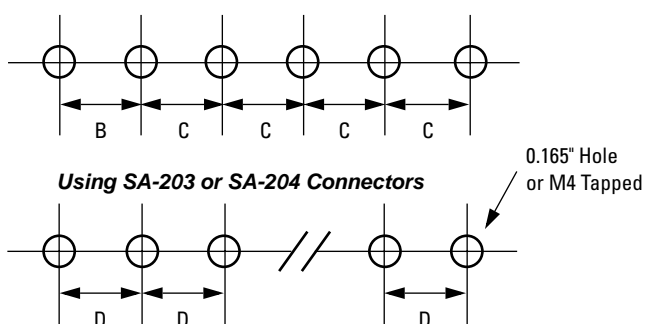

2. Drawings are not to scale.

Dimensions, continued

Collective Panel Mounting

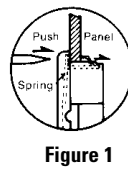
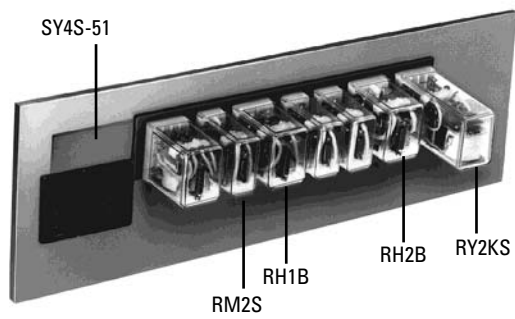

SH and SY series panel mount sockets are designed to mount collectively in panel cut-outs. Insert socket with mounting springs facing the top and bottom edge of the panel cut-out. Push the socket until the mounting spring clips onto the panel. (See Figure 1.)

Dimension Table

Part No.	Width	Relay
SY4S-51	1.063"	RY4S, RY42, RY2KS, RY2LS, RM2S
SH4B-51	1.772"	RH4B
SH3B-51	1.418"	RH3B, RH2LB
SH2B-51	1.063"	RH2B, RAMB, RBMB
SH1B-51	0.709"	RH1B, RAHB, RBHB
SY2S-51	0.709"	RY2S, RY22S

How to Calculate Cutout Length (L)

Cutout L = A (Total Overall Width of Each Socket) - 0.221" (+ 0", - 0.020")

Example:

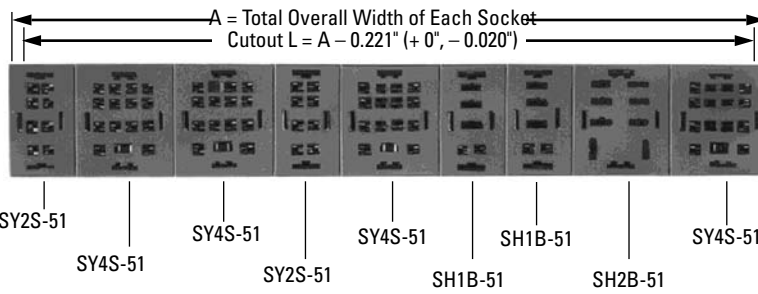

$$L = [0.709" + 1.063" + 1.063" + 0.709" + 1.063" + 0.709" + 1.063" + 1.063"] - 0.221" = 7.93"$$

$$L = 7.93" (+ 0", - 0.020")$$

Mounting Plate

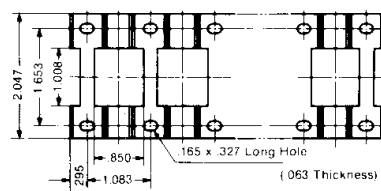

F